

NOMBRE

BEBEDERO AVES ECO RECICLADO 1,5 LTS. CON PATAS

REFERENCIA

11083

CARACTERÍSTICAS DE PRODUCTO

MATERIAL

POLIPROPILENO RECICLADO

COLOR

MEZCLA ALEATORIA

PESO

0,160 kg

TIPO DE CIERRE

GIRO

ACCESORIOS

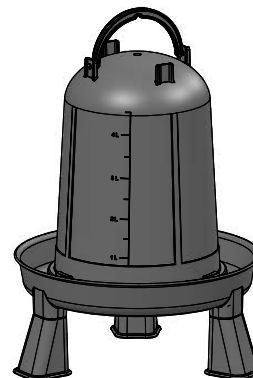

CROQUIS

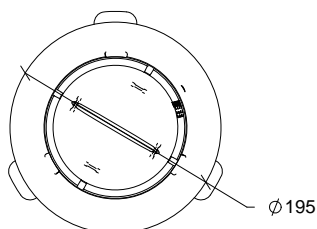
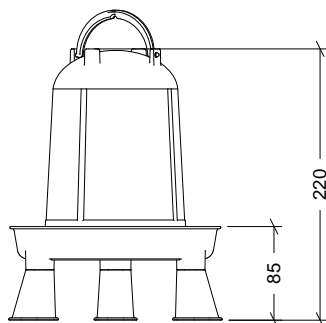

DESPIECE

Nº	DESCRIPCIÓN
1	ASA
2	BIDÓN
3	PLATO
4	PATAS

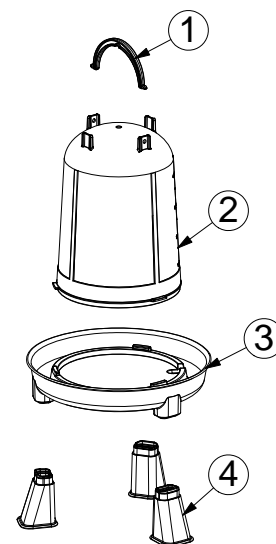

CARACTERÍSTICAS DE EMBALAJE

TIPO DE PACKING

CAJA

CANTIDAD

10 Unidades

DIMENSIONES

330×255×295 mm

PESO

1,85 kg

VOLUMEN

0,025 m³

PALET EUROPEO

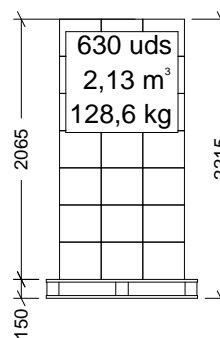

PALET AMERICANO

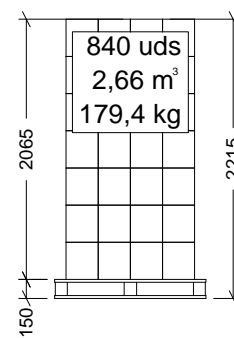

PESO PALET EUROPEO: 12 kg

PESO PALET AMERICANO: 24 kg

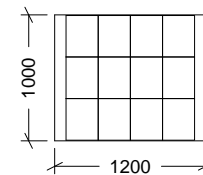
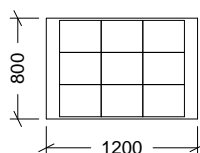

Cotas en mm