

NOMBRE

**TOLVA PLÁSTICO AVES 4 kg - PISTACHO**

REFERENCIA

**11151**

**CARACTERÍSTICAS DE PRODUCTO**

MATERIAL

POLIPROPILENO ANTI-UV

COLOR

PISTACHO

PESO

0,537 kg

TIPO DE CIERRE

PRESIÓN

ACCESORIOS

CUERDA Y FRENO



CROQUIS

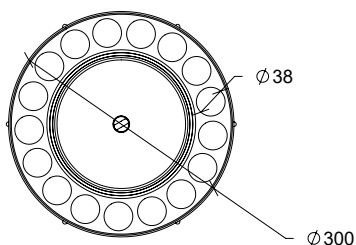
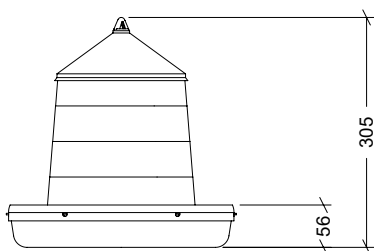

DESPIECE

Nº	DESCRIPCIÓN
1	TAPADERA
2	CONO
3	PLATO

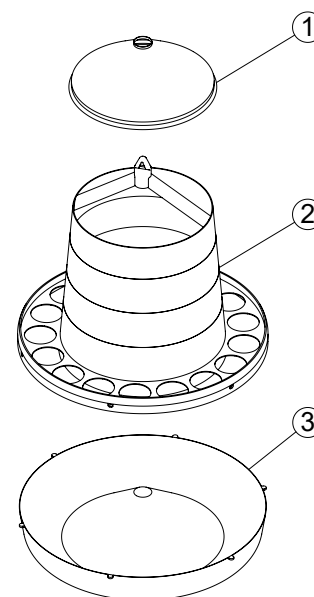

**CARACTERÍSTICAS DE EMBALAJE**

TIPO DE PACKING

CAJA

CANTIDAD

10 Unidades

DIMENSIONES

310x310x770 mm

PESO

6,080 kg

VOLUMEN

0,074 m<sup>3</sup>

PALET EUROPEO

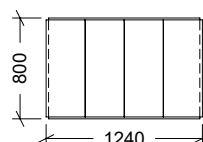
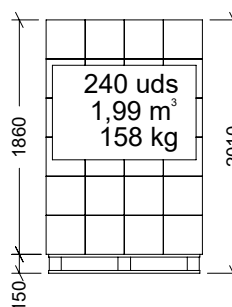

PALET AMERICANO

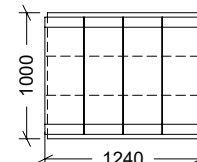
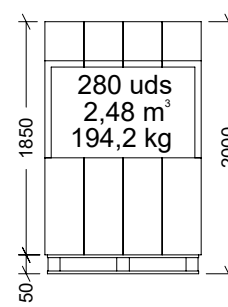

**PESO PALET EUROPEO: 12 kg**

**PESO PALET AMERICANO: 24 kg**