

NOMBRE

TOLVA PLÁSTICO AVES 2 kg - PISTACHO

REFERENCIA

11154

CARACTERÍSTICAS DE PRODUCTO

MATERIAL

POLIPROPILENO ANTI-UV

COLOR

PISTACHO

PESO

0,248 kg

TIPO DE CIERRE

PRESIÓN

ACCESORIOS

CUERDA Y FRENO



CROQUIS

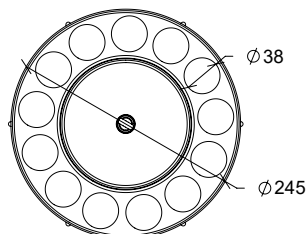
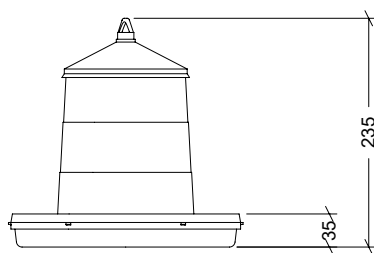

DESPIECE

Nº	DESCRIPCIÓN
1	TAPADERA
2	CONO
3	PLATO

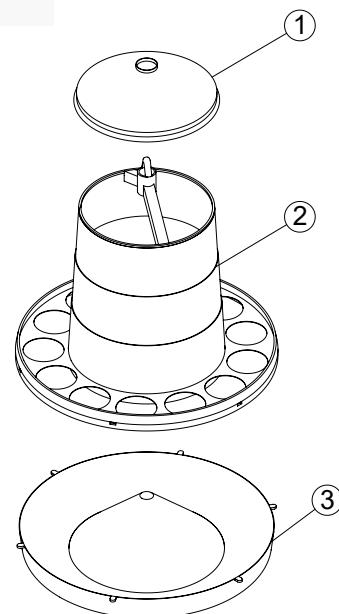

CARACTERÍSTICAS DE EMBALAJE

TIPO DE PACKING

CAJA

CANTIDAD

10 Unidades

DIMENSIONES

245x245x497 mm

PESO

2,950 kg

VOLUMEN

0,030 m³

PALET EUROPEO

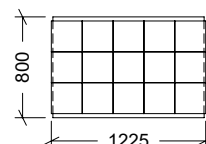
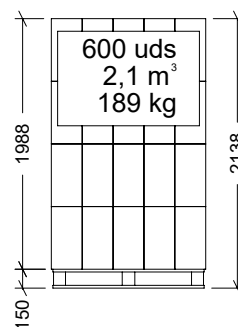

PALET AMERICANO

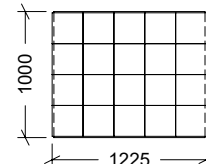
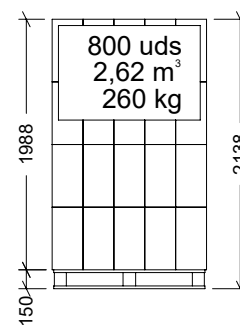

PESO PALET EUROPEO: 12 kg

PESO PALET AMERICANO: 24 kg