

PRODUCT NAME

PLASTIC POULTRY FEEDER 2 kg

REFERENCE

11155

MAIN FEATURES

MATERIAL

ANTI-UV POLYPROPYLENE

COLOR

RED

WEIGHT

0,248 kg

TYPE OF CLOSURE

PRESSURE

ACCESSORIES

CORD AND HEIGHT ADJUSTER



SKETCH

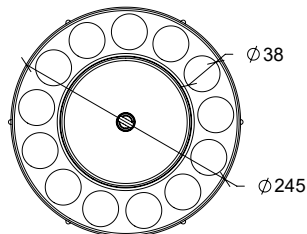
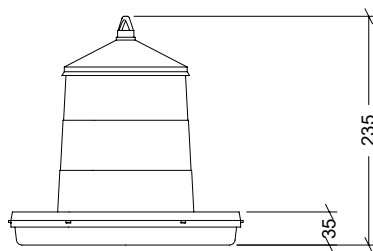

SPARE PARTS

Nº	DESCRIPTION
1	LID
2	CONE
3	BASE

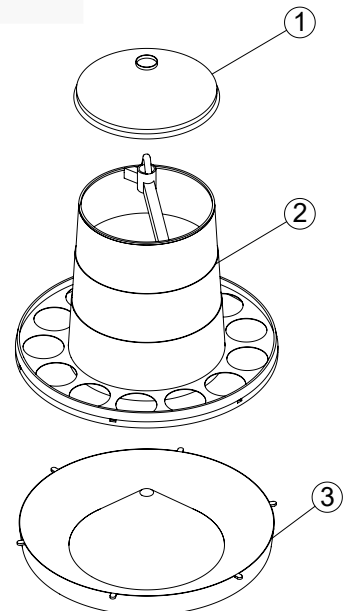

PACKAGING CHARACTERISTICS

PACKAGE TYPE

CARDBOARD BOX

QUANTITY

10 PIECES

DIMENSIONS

245x245x497 mm

WEIGHT

2,950 kg

VOLUME

0,030 m³

EURO PALLET

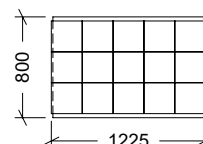
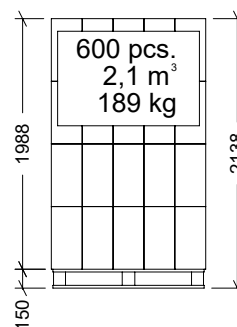

AMERICAN PALLET

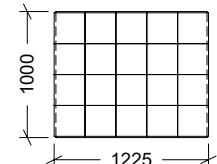
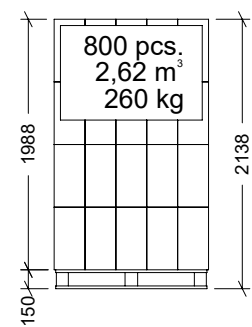

EURO PALLET WEIGHT: 12 kg

AMERICAN PALLET WEIGHT: 24 kg