

NOMBRE

**TOLVA AVES BIO 2 KGS.**

REFERENCIA

**11243**

**CARACTERÍSTICAS DE PRODUCTO**

MATERIAL

POLIETILENO BIOBASADO

COLOR

BLANCO - AMARILLO

PESO

0,248 kg

TIPO DE CIERRE

PRESIÓN

ACCESORIOS

CUERDA Y FRENO

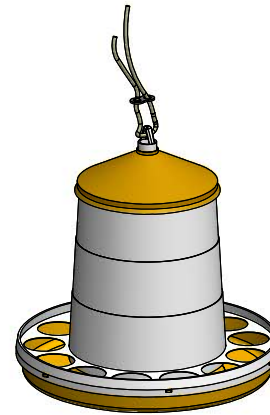

CROQUIS

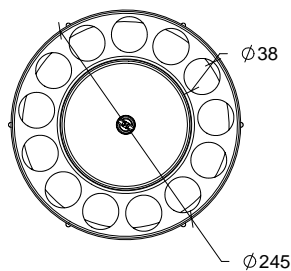
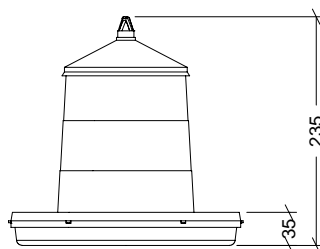

DESPIECE

Nº	DESCRIPCIÓN
1	TAPADERA
2	CONO
3	PLATO

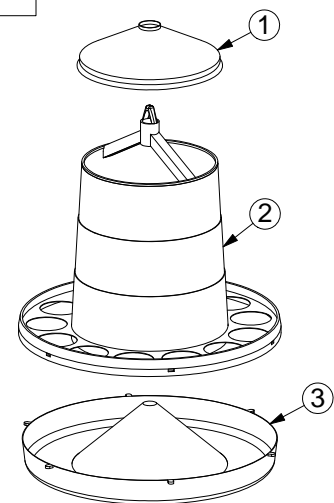

**CARACTERÍSTICAS DE EMBALAJE**

TIPO DE PACKING

CAJA

CANTIDAD

10 Unidades

DIMENSIONES

245x245x497 mm

PESO

2,950 kg

VOLUMEN

0,030 m<sup>3</sup>

PALET EUROPEO

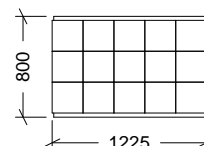
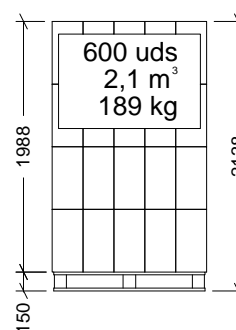

PALET AMERICANO

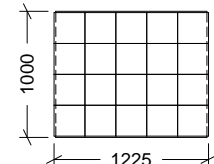
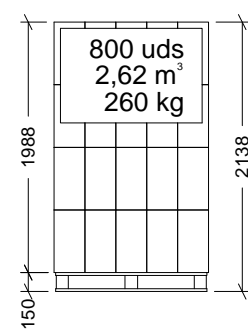

**PESO PALET EUROPEO: 12 kg**

**PESO PALET AMERICANO: 24 kg**