

NOMBRE

REFERENCIA

COMEDERO POLLITOS METÁLICO 50 cm REJILLA ANCHA PINTADO

11305

CARACTERÍSTICAS DE PRODUCTO

MATERIAL

ACERO GALVANIZADO

COLOR

PISTACHO

PESO

0,513 kg

TIPO DE CIERRE

PRESIÓN

ACCESORIOS

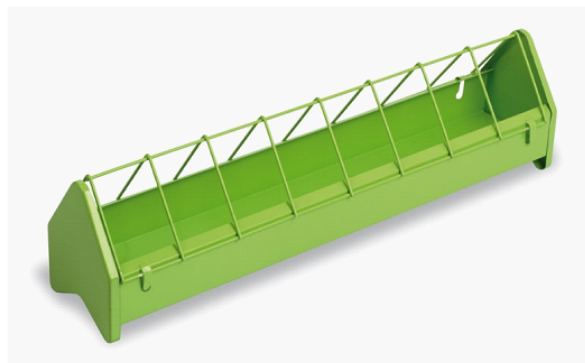

CROQUIS

DESPIECE

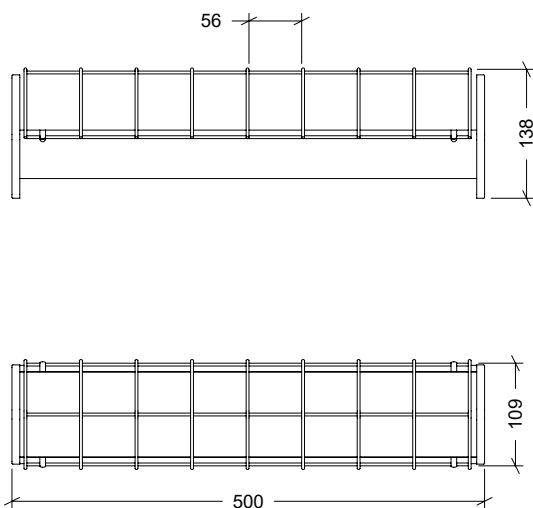

Nº	DESCRIPCIÓN
1	REJILLA
2	CUERPO

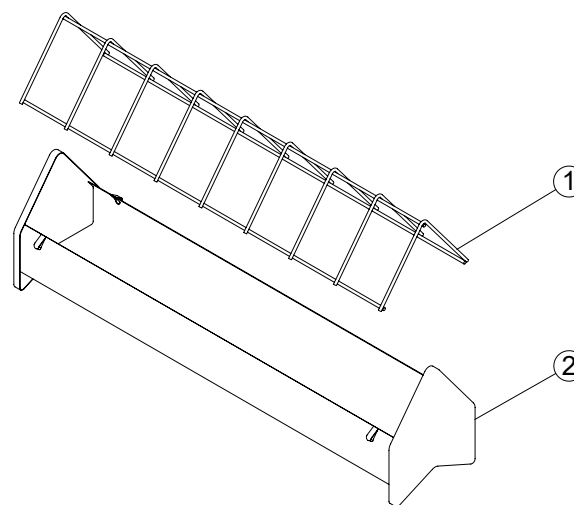

CARACTERÍSTICAS DE EMBALAJE

TIPO DE PACKING

CAJA

CANTIDAD

6 UNIDADES

DIMENSIONES

510x250x400 mm

PESO

3,550 kg

VOLUMEN

0,051 m³

PALET EUROPEO

PALET AMERICANO

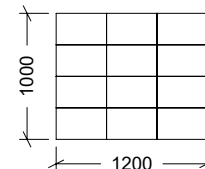
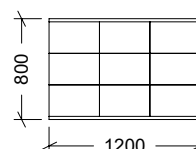
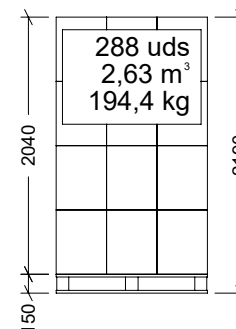
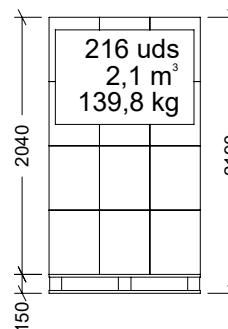

PESO PALET EUROPEO: 12 kg

PESO PALET AMERICANO: 24 kg