

NAME

REFERENCE

**METAL CHICK FEEDER WIDE SPACING 50 CM. GALVANISED**

**11315**

**PRODUCT FEATURES**

MATERIAL

GALVANISED STEEL

COLOR

GALVANIZED

WEIGHT

0,772 kg

CLOSURE TYPE

PRESSURE

ACCESSORIES

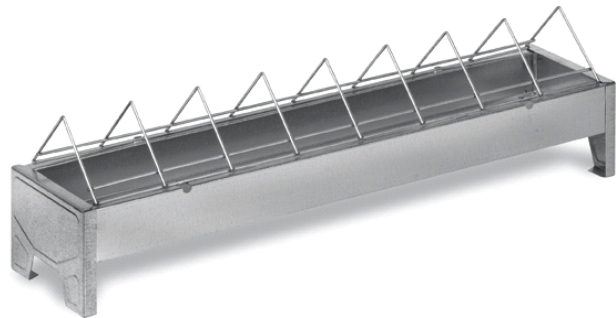

SKETCH

SECTIONAL

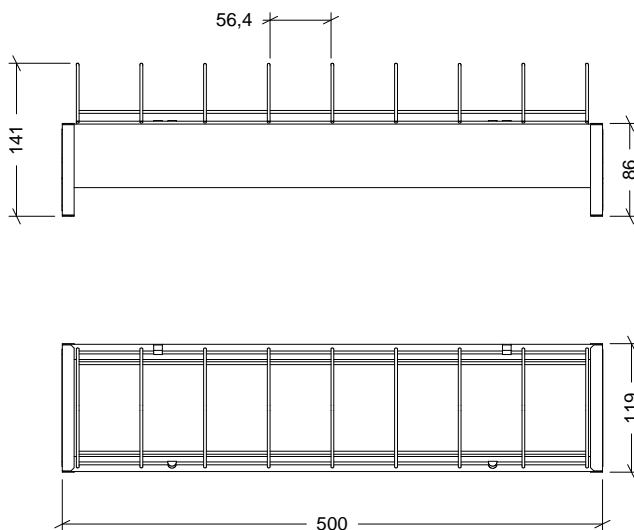

Nº	DESCRIPTION
1	GRILLE
2	BODY

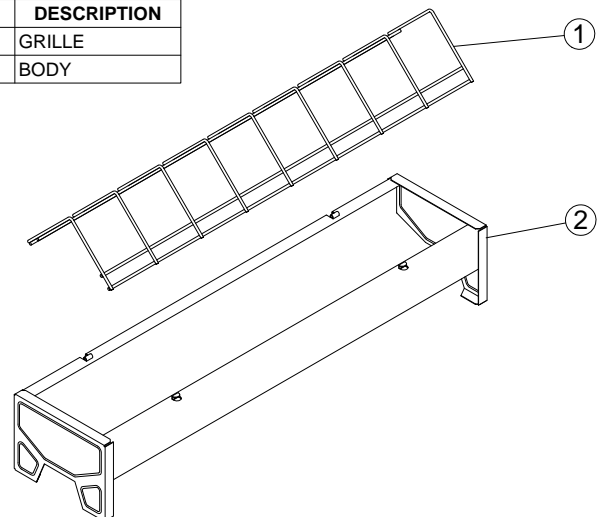

**PACKAGING FEATURES**

PACKAGING TYPE

SHRINK WRAPPING

UNITS/PACKAGING

5 Units

PACKING DIMENSIONS

515x245x202 mm

PACKING WEIGHT

3,770 kg

PACKING VOLUME

0,025 m<sup>3</sup>

EUROPALLET

AMERICAN PALLET

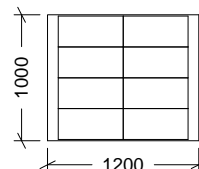
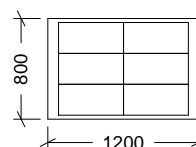
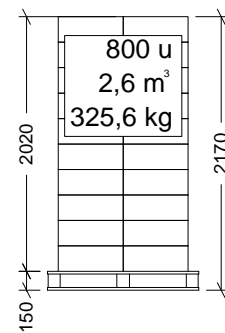
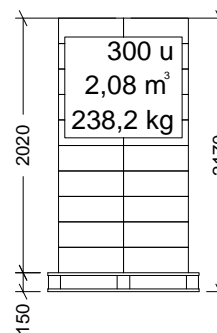

**EUROPALLET WEIGHT: 12 kg**

**AMERICAN PALLET WEIGHT: 24 kg**

Dimensions in mm