

NAME

METAL CHICK FEEDER NARROW SPACING 50 CM.

REFERENCE

11320

PRODUCT FEATURES

MATERIAL

GALVANISED STEEL

COLOR

GALVANIZED

WEIGHT

0,783 kg

CLOSURE TYPE

PRESSURE

ACCESSORIES

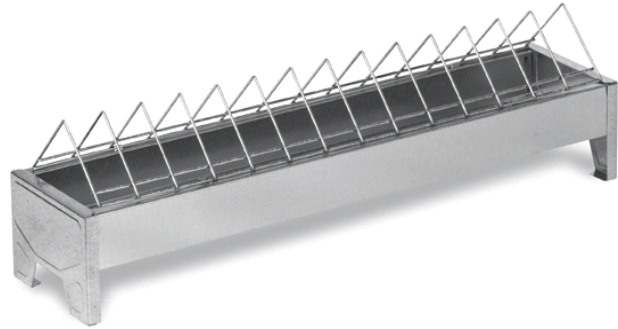

SKETCH

SECTIONAL

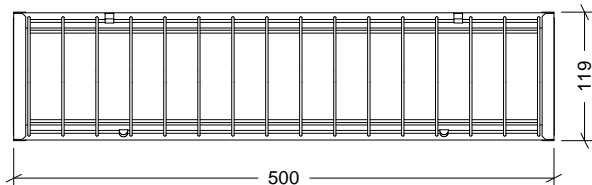
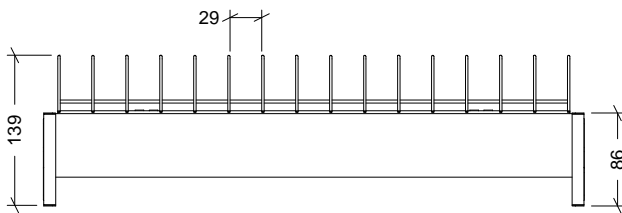

| Nº | DESCRIPTION |
|----|-------------|
| 1 | GRILLE |
| 2 | BODY |

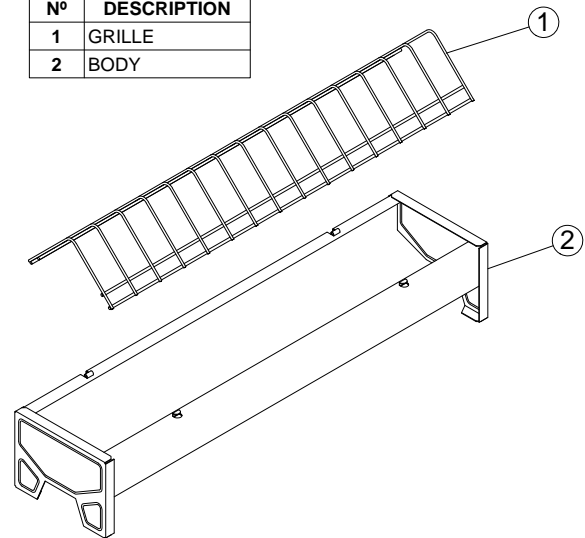

PACKAGING FEATURES

PACKAGING TYPE

SHRINK WRAPPING

UNITS/PACKAGING

5 Units

PACKING DIMENSIONS

510x370x120 mm

PACKING WEIGHT

3,830 kg

PACKING VOLUME

0,023 m³

EUROPALLET

AMERICAN PALLET

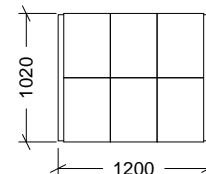
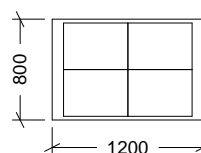
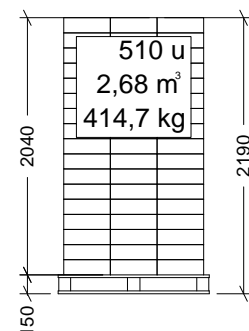
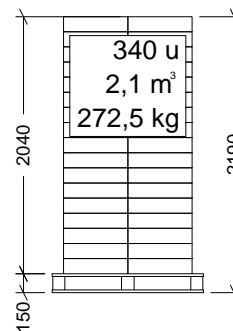

EUROPALLET WEIGHT: 12 kg

AMERICAN PALLET WEIGHT: 24 kg

Dimensions in mm